

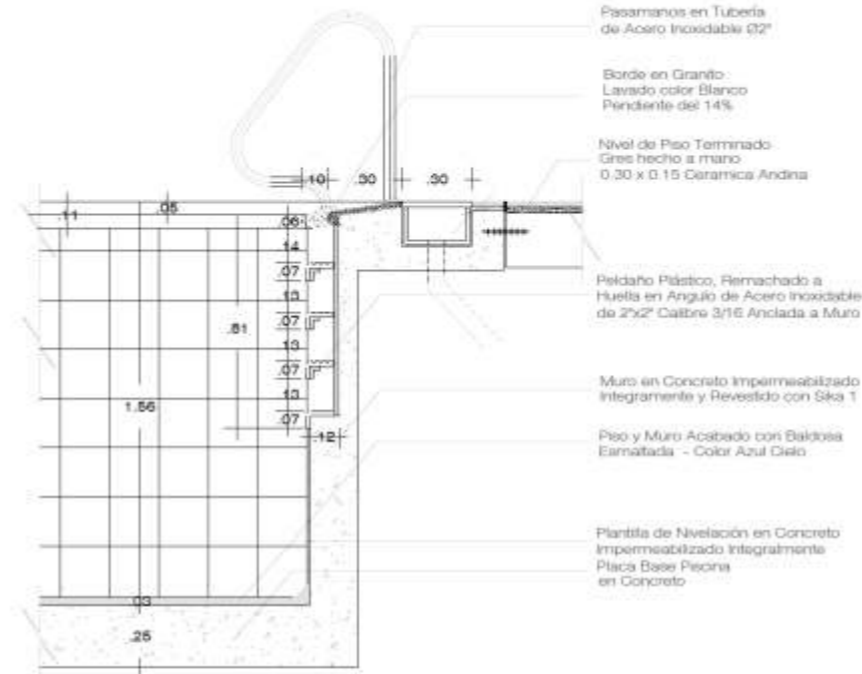

DETALLE 02 - ESCALERA METÁLICA PISCINA
ESC: 1/20

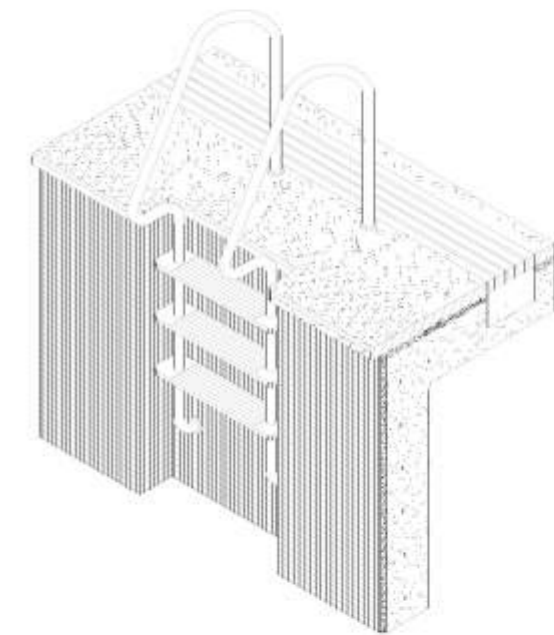

EJEMPLO CONFIABLE
ESC: 1/10

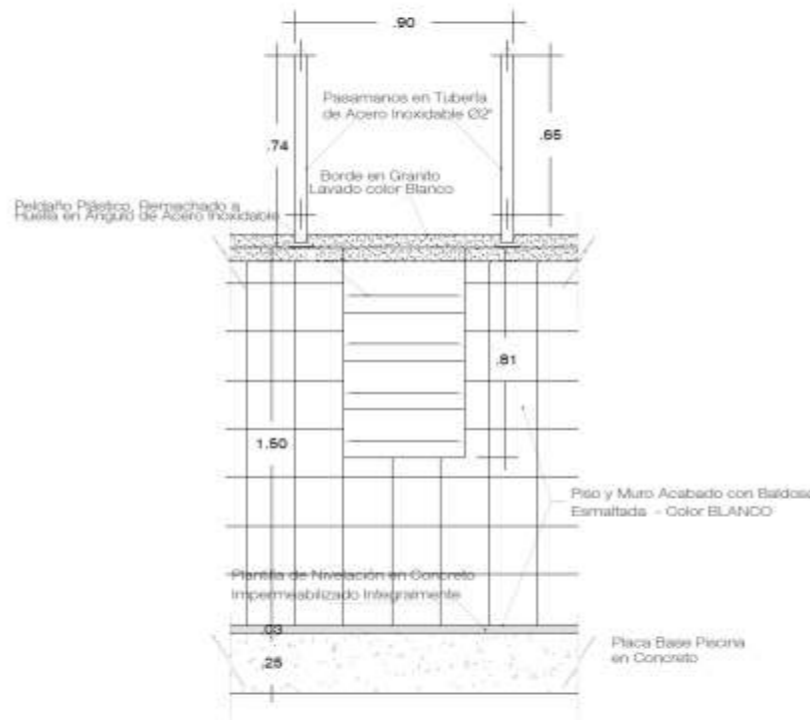
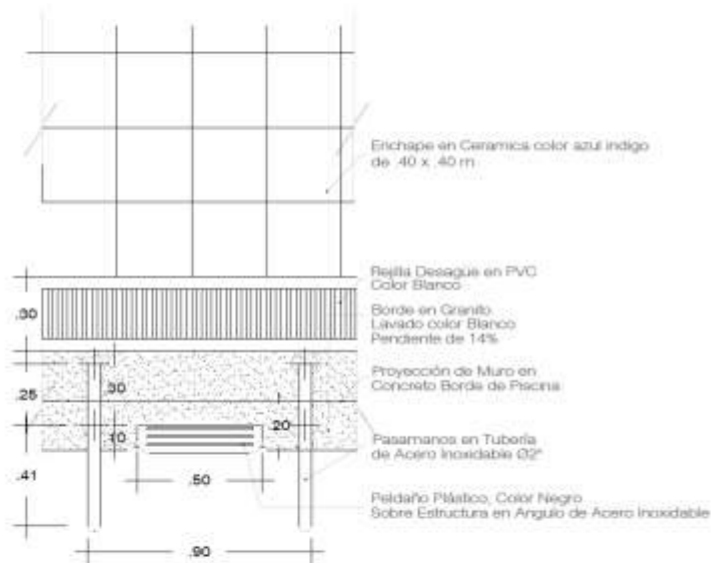

ISÓMETRICO DE BARANDA
ESC: 1/10

PROPUESTA DE UN CENTRO DE REHABILITACIÓN Y TRATAMIENTO PARA ADOLESCENTES Y JÓVENES CON PROBLEMAS DE SALUD MENTAL DEBIDO AL CONSUMO DE DROGAS TACNA 2018

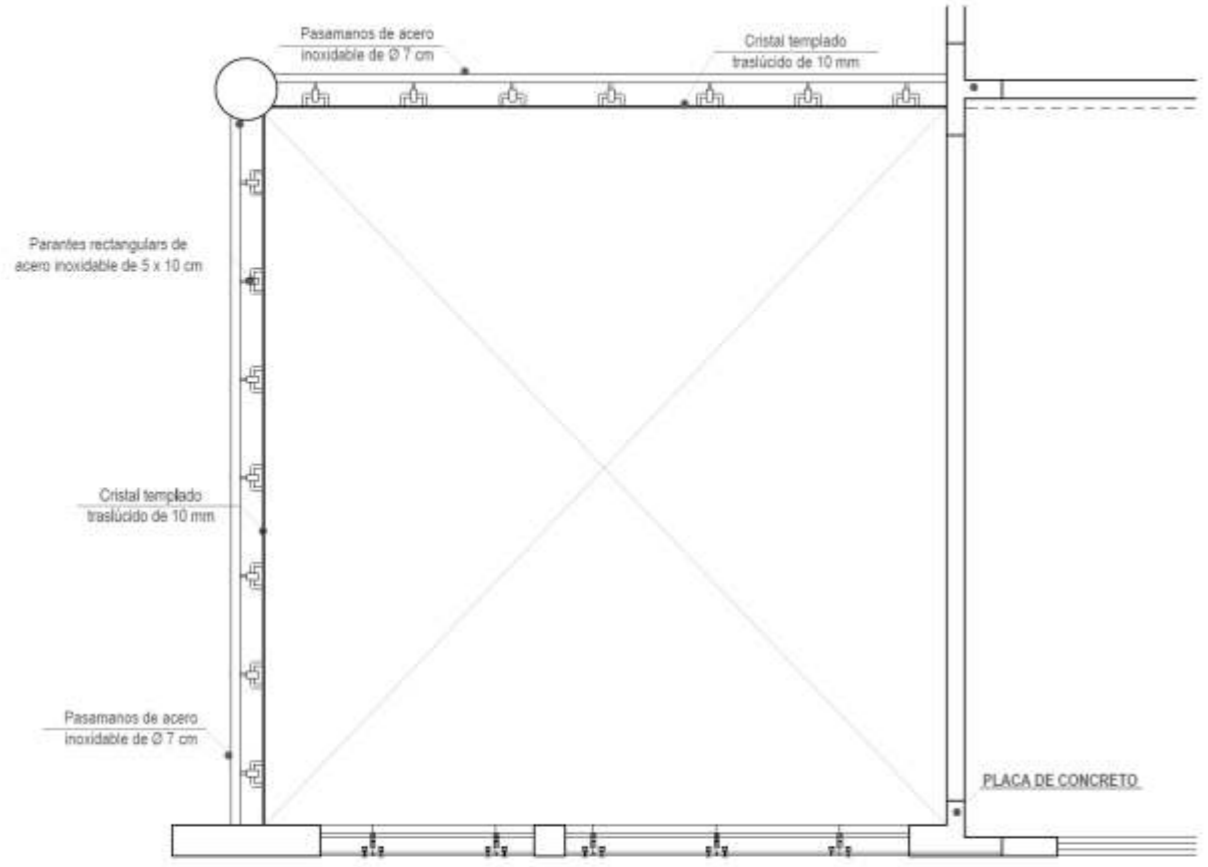

DETALLE 01 - BARANDA DE ALUMINIO Y VIDRIO
ESC: 1/20

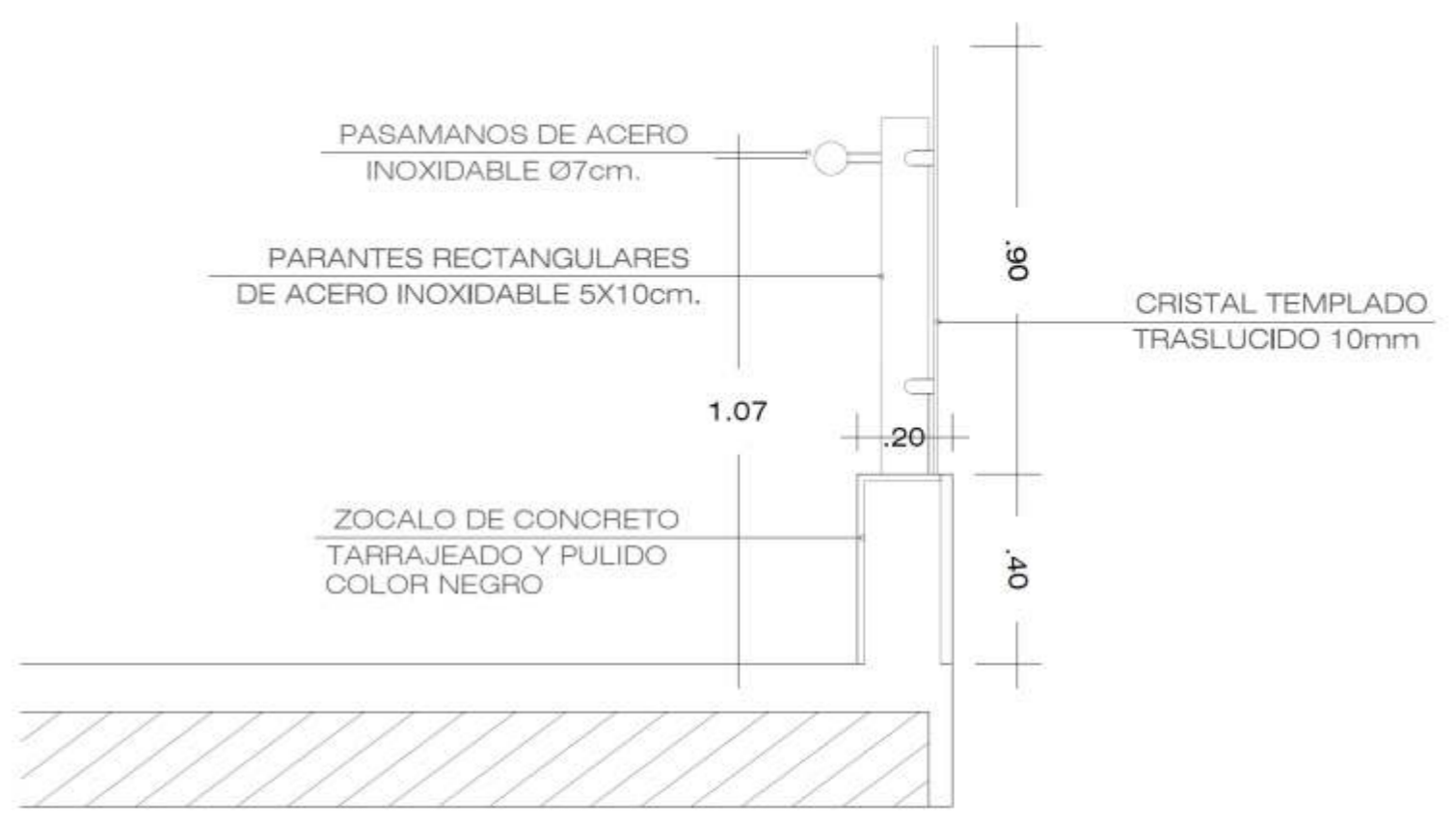

CORTE - ANCLAJE DE BARANDA
ESC: 1/5



DETALLE 01 - BARANDA EN TERRAZA
ESC: 1/20

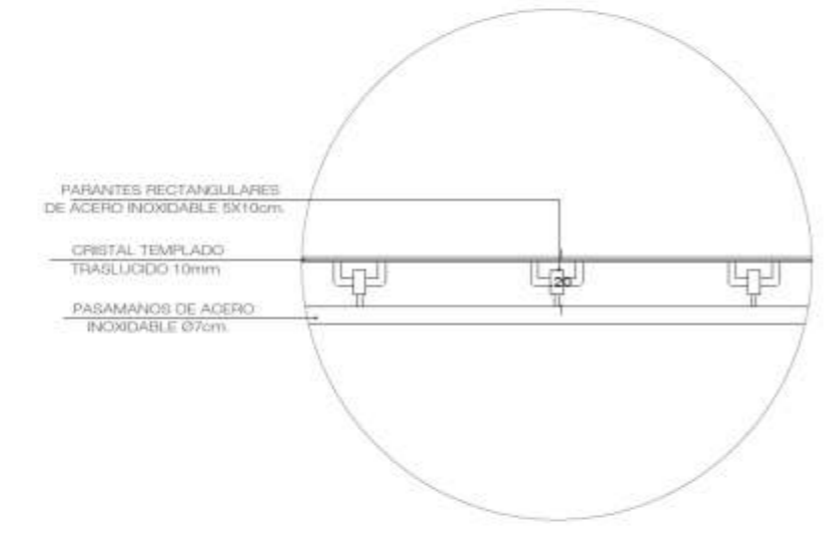

PLANTA DE BARANDA A DETALLE
ESC: 1/10

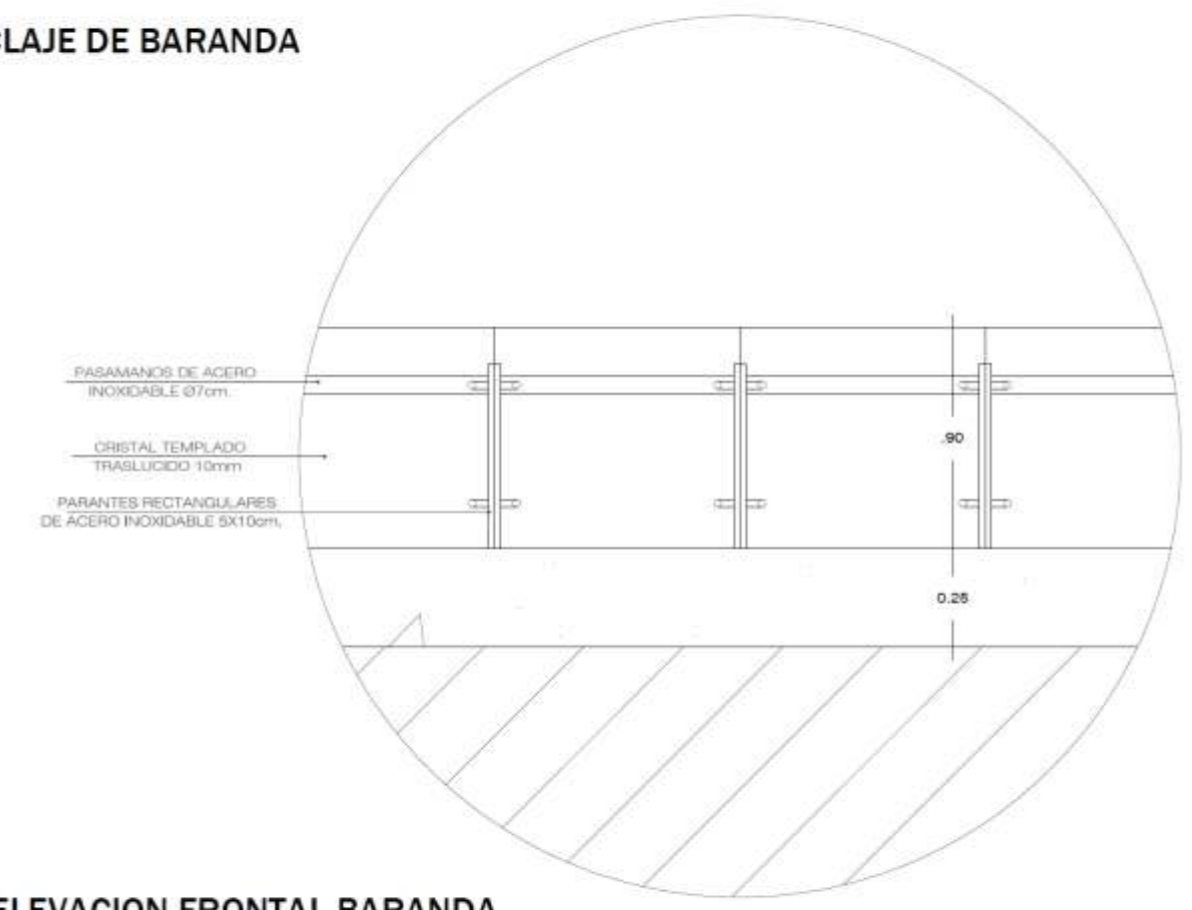

ELEVACION FRONTAL BARANDA
ESC: 1/10

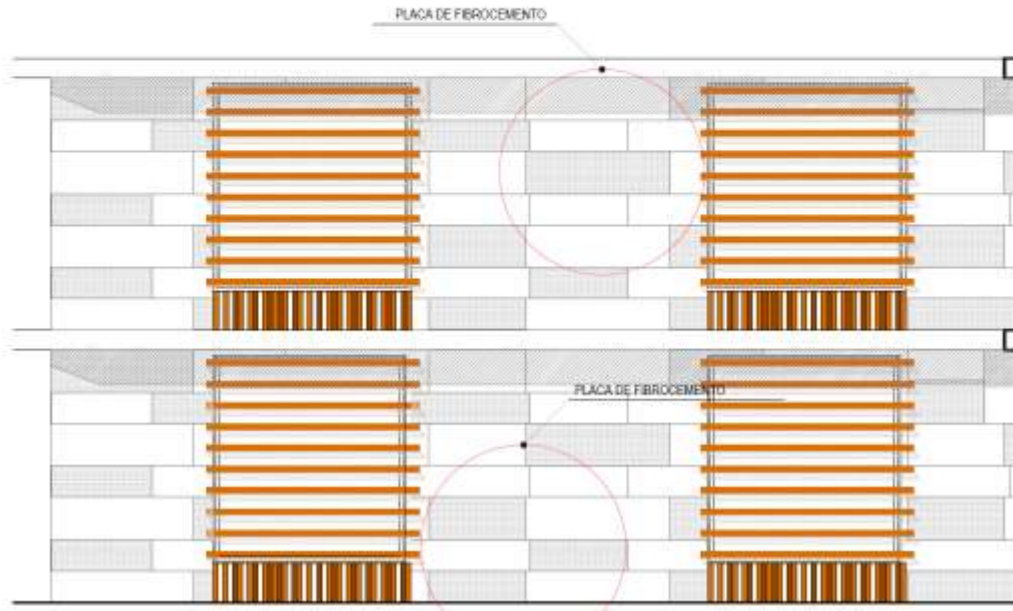

DETALLE 02 - ESCALERA METÁLICA PISCINA
ESC: 1/20

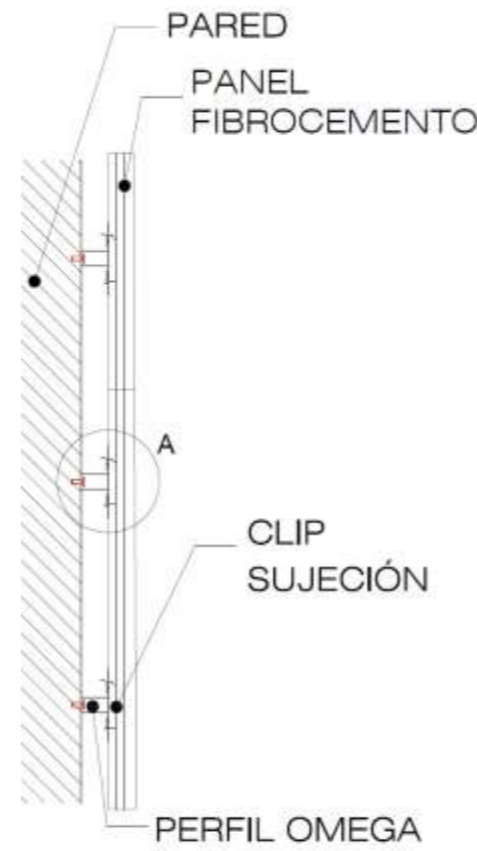

CORTE - ANCLAJE DE PLACA DE FIBROCEMENTO
ESC: 1/10

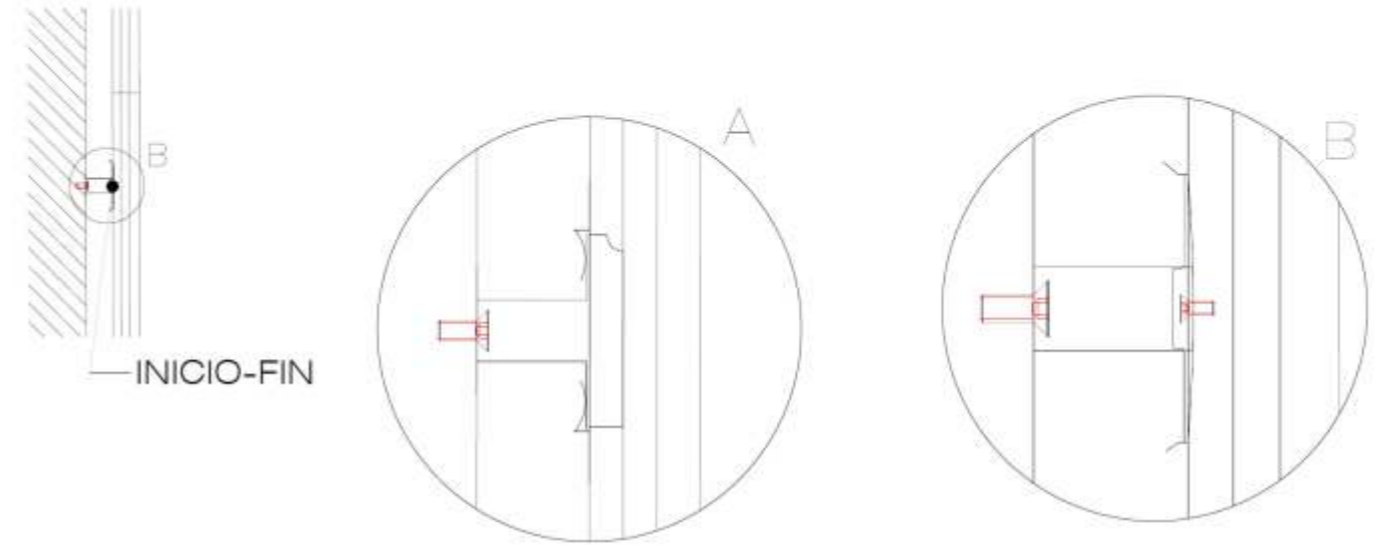

ANCLAJE TIPO A Y TIPO B
ESC: 1/5

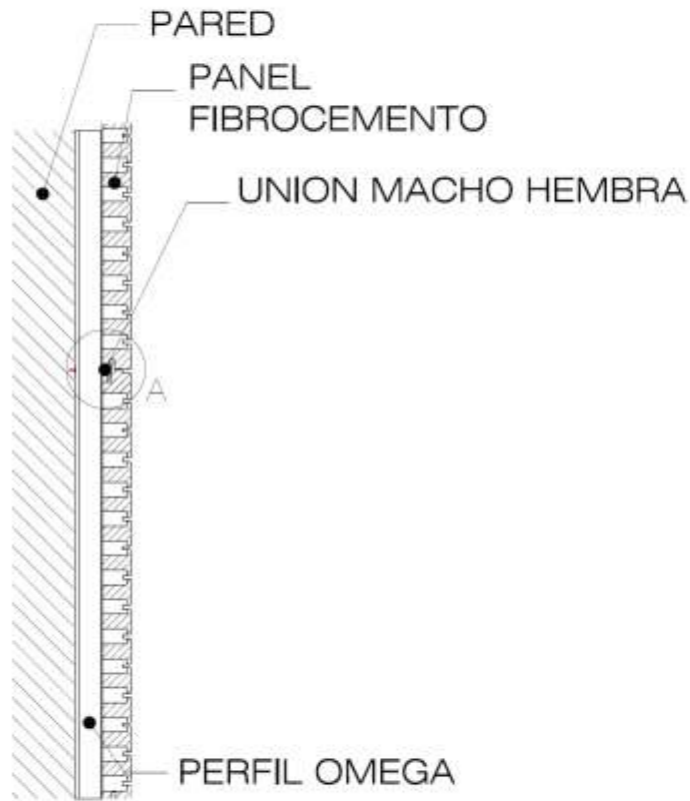

VISTA LATERAL INICIO / FIN
ESC: 1/10

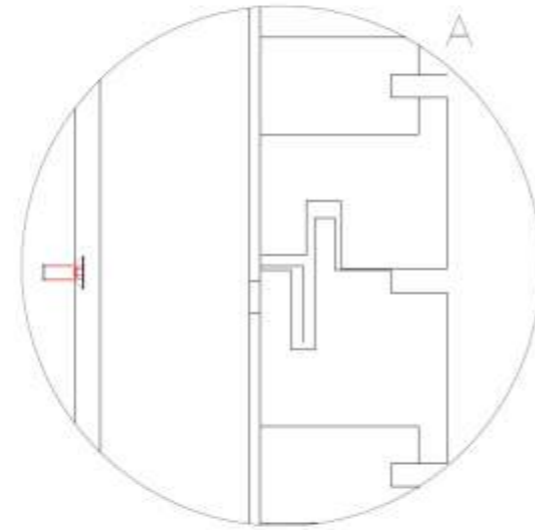

VISTA LATERAL INICIO / FIN - DETALLE A
ESC: 1/5

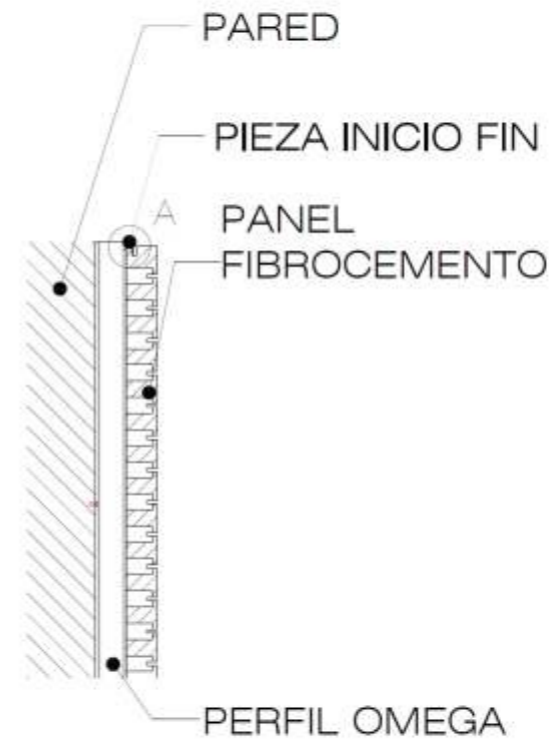

VISTA LATERAL CLIP SUJECION
ESC: 1/10

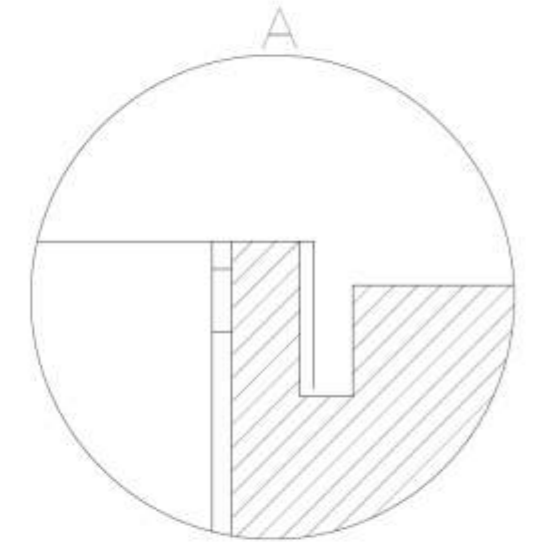

VISTA LATERAL CLIP SUJECION - DETALLE A
ESC: 1/5